

The logo for 'AIR SELFIE' is displayed in a clean, modern font. The word 'AIR' is positioned above 'SELFIE'. The letter 'i' in 'AIR' is lowercase and features a small blue square as a dot. The letters 'S', 'E', 'L', 'F', 'I', and 'E' in 'SELFIE' are all uppercase. The letters are widely spaced and rendered in a dark grey color.

AIR
SELFIE

INSTRUCTION MANUAL

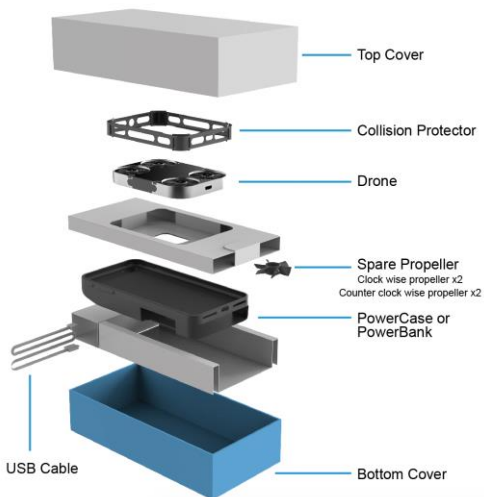



In the Box - contents

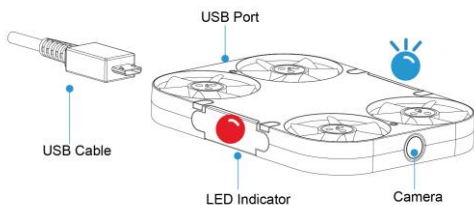
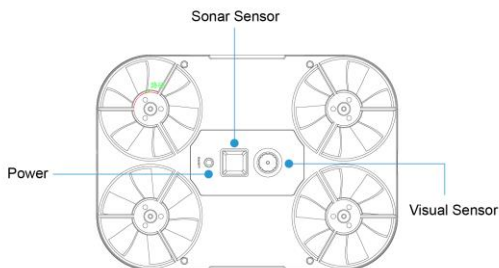

Getting to know your AirSelfie



LED Legend

-  Red Light Solid = Charging
-  Red Light Off = Fully Charged
-  Blue Light Solid Fly = Status Normal
-  Blue Light Flash once = Take a picture
-  Blue Light Flash slowly = Recording

The AirSelfie App

Developed exclusively for AirSelfie, the AirSelfie app allows users to control the flight path of the device and its camera. Users can also download pictures and videos directly from the device and share them instantaneously on Social Media platforms.

Get the app

The AirSelfie app is available for free download on both the App Store and Google Play.



The AirSelfie App supports all versions of Android 4.0 and above and all versions of iOS 8.0 and above.

General settings before your AirSelfie's first flight

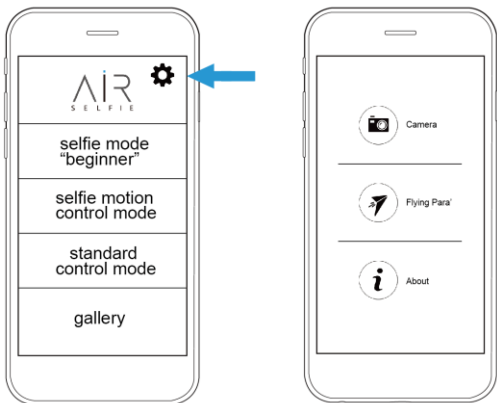

Camera

- Camera time delay function:
3sec / 5sec / 10sec
Use this function to delay the shot by 5 or 10 seconds. This will allow you to put your smartphone away before posing for the picture.
- Multiple shot:
3pics / 5pics / 10pics
(use this function to take multiple shots at the same time).

Flying Para'

- Flying Speed:
Slow / Medium / Fast
Select the flight speed you feel comfortable with.

About

- Check the firmware version

App Icons

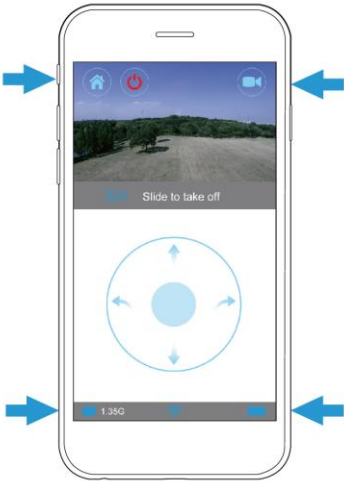

Home



Wi-Fi Connected



Wi-Fi Signal Weak



Wi-Fi Disconnected



Remaining Memory



Fully Charged



Battery Low



Start/Stop Recording



Take a Picture



Emergency/Power off

Optimal operating conditions

Outdoors

- Do not operate under bad weather conditions (raining, snowing, wind etc).
- Do not fly device over crowded areas or motor traffic.
- Fly the AirSelfie in plain sight, and away from obstructions or water.
- It is advisable to not operate the device from over 20 metres of distance away.

Indoors

- The AirSelfie uses visual positioning technology for optimal hovering performance. For maximum stability, it is advised to fly the device over flat and multicoloured surfaces.
- Ensure there is sufficient lighting whenever using the device indoors.
- Avoid flying the device over surfaces which absorb sound, such as rugs or carpets.

Memory

There is a built-in 4GB memory card for storing photos and videos. Photos and videos can be downloaded to your PC, Mac or smartphone using either the USB cable provided or a Wi-Fi connection.

The USB port can be used for data transfer via a PC or a Mac only when the AirSelfie is switched on.

Battery & Charging

We highly recommend charging your AirSelfie using the power case or power bank chargers provided in the product kit.

Power Case Specs

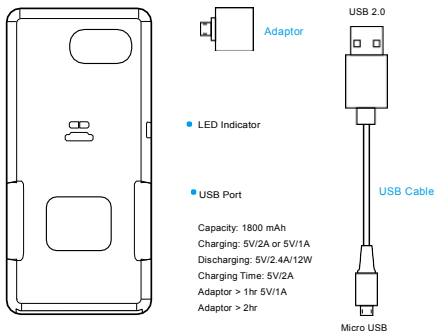

Introduction of LED indicator

Green LED: Indicate current capacity of battery

Flash once: 0~25% capacity

Flash twice: 25~50% capacity

Flash 3 times: 50~75% capacity

Flash 4 times: 75~100% capacity

Solid light up: 100% capacity, battery fully

Red LED: Discharging

Attention

Use 5V qualified charger charging

Power Case. Avoid use charger with nominal voltage above 5V.

Duration charging AirSelfie or other electrical products, discharging LED quenching means Power Case fully discharged, please charge Power Case.

Battery & Charging

Power Bank Specs

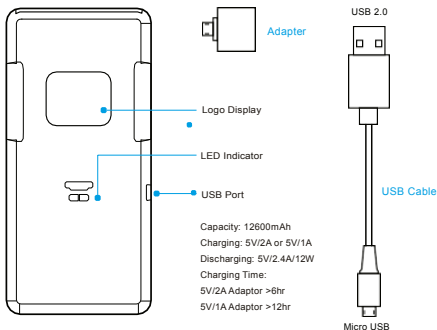

Introduction of LED indicator

Green LED: Indicate current capacity of battery

Flash once: 0~25% capacity

Flash twice: 25~50% capacity

Flash 3 times: 50~75% capacity

Flash 4 times: 75~100% capacity

Solid light up: 100% capacity, battery fully

Red LED: Discharging

Attention

Use 5V qualified charger charging

Power Bank. Avoid use charger with nominal voltage above 5V.

Duration charging AirSelfie or other electrical products, discharging LED quenching means Power Bank fully discharged, please charge Power Bank.

Caution!

- PowerCase/PowerBank use Li-ion Battery
- Do not disassemble/reassemble PowerCase/PowerBank.
- Do not place PowerCase/PowerBank into fire or water.
- Do not charge or use PowerCase/PowerBank near heat concentrated region.
- Do not pierce or damage PowerCase/PowerBank.
- Do not charge PowerCase/PowerBank with High Voltage Device.
- Do not use leak, smelly, deformed PowerCase/PowerBank and battery.
- Do not place PowerCase/PowerBank in microwave or high pressure vessels.
- Do not expose PowerCase/PowerBank under direct sunlight.
- Do not place PowerCase/PowerBank where child can approach.

Charging the Power Case / Power Bank

Insert the micro-USB end of the cable into the power bank and the USB 2.0 end into a 5V plug. Your power bank is fully charged when the LED indicates a green light.

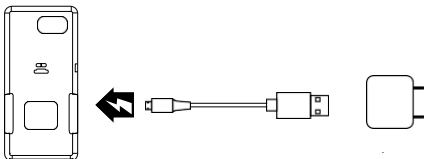

Charging the AirSelfie

Insert the AirSelfie into either the power case or power bank. A red LED light indicates that the device is charging.

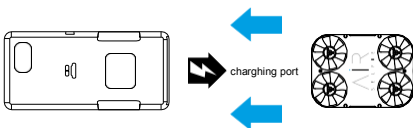

Charging your smartphone with the power case/bank

Plug the adaptor onto the USB 2.0 port, inserting the other side of the adaptor into the power bank. Insert the micro-USB port into the smartphone that requires charging. A red LED light indicates that the device is charging.

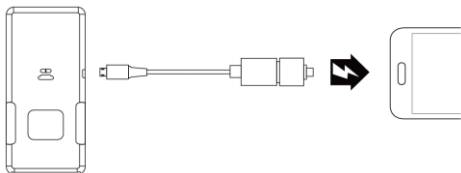

Powering the AirSelfie on and/or off

To power on or off, push the power button as shown in the figure below and hold for 1.5 seconds. A blue LED light and a beep sound will be played when the device is switched on.

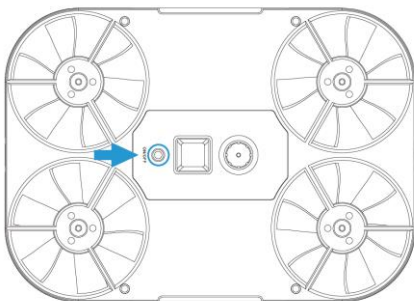

First flight

We highly recommend taking your first AirSelfie flight indoors, using the safety cover included in the product kit.



Emergency stop

In case of emergency, stop the AirSelfie even in mid-flight by pressing the button 

Linking your smartphone to the AirSelfie

Download the AirSelfie app from the App Store or Google Play onto your smartphone.

Once the AirSelfie is on

1. Proceed to the Wi-Fi menu in your smartphone's settings
2. Select the AirSelfie network which will appear on the screen as "AirSelfie_operating code number".
3. The password will be the operating code number, which is the combination of letters and numbers after "AirSelfie".



Using the AirSelfie

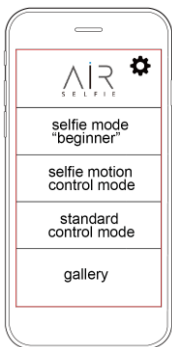

Control your AirSelfie's flight through 3 different flight modes: 1) selfie mode "beginner", 2) selfie motion control mode, 3) standard control mode.

The TossFly & the TouchLand

Make sure your AirSelfie has been successfully linked to the AirSelfie app before tossing the device into flight; select one of the flight modes to check that the AirSelfie camera is streaming images real time to your smartphone.

Starting a flight: the TossFly

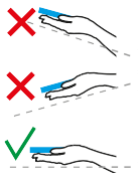

1. Place the AirSelfie in your palm, keeping it as flat and parallel to the ground as possible (if the device is not properly levelled, an error message might appear on the screen).
2. Following the instructions on the screen, slide your finger over the bar that says "Slide to Take Off". This should start the AirSelfie's propellers, signaling that the device is ready for take-off.
3. Gently push the AirSelfie upwards into the air for it to take flight.

Concluding a flight: the TouchLand

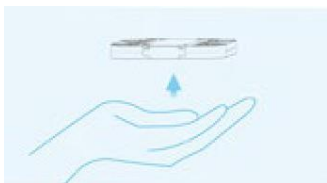

While the AirSelfie is in mid-hover, place your palm beneath it. The AirSelfie will then land in your palm, stopping its propellers. Now you are ready to download your AirSelfie pictures and videos to your smartphone!

Selfie Motion control mode



Operation sequence

1. In Selfie Motion Control Mode, in order to prevent confusing the device during flight, make sure that the camera is facing you. This ensures that the controls will not be inverted.
2. Slide to take off



3. Do the TossFly (pg 14)
4. Tapping on any command icon will have the smartphone take control of the AirSelfie (notifying you with a vibration)
5. Use the following commands to move the drone in the desired position

Commands

- Tap and hold the mid button to activate Gravity Mode.
- Slide mid button
- Sliding upward brings the device up. ↑
- Sliding downward brings the device down. ↓
- Sliding left turns the camera left. ↶
- Sliding right turns the camera. ↷

Type of controlling

VIRTUAL JOYSTICK

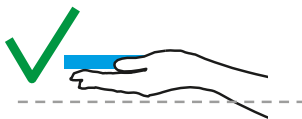

- slide virtual joystick to move AirSelfie (smartphone position must be levelled)

TILT MODE

Tap in the center and tilt the smartphone:

- to the left to move AirSelfie to the left. (1)
- to the right to move AirSelfie to the right. (2)
- away from yourself to move AirSelfie away from you. (3)
- towards yourself to move AirSelfie towards you. (4)

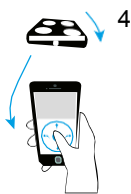

2. Taking a photo or a video

TO TAKE A PICTURE TAP ON THE SCREEN



Use the delay function (pg 5) to delay the shot by 3, 5 or 10 seconds.

This will allow you to put your smartphone away before posing for the picture.

TO RECORD A VIDEO CLICK ON THE ICON CLICK TO STOP RECORDING



3. Use the commands to return the AirSelfie to you

4. Do the **TOUCHLAND**

5. Go to Home (click on the  icon) to **DOWNLOAD PHOTOS & VIDEOS** (pg 26)

FOR EMERGENCY STOP PRESS 

Selfie mode “beginner”

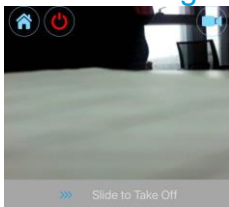

Operation sequence

1. In Selfie mode “beginner”, in order to prevent confusing the device during flight, make sure that the camera is facing you. This ensures that the controls will not be inverted.
2. Slide to take off



3. Do the TossFly (pg 14)
4. Tapping on any command icon will have the smartphone take control of the AirSelfie (notifying you with a vibration)
5. Use the following commands to move the drone in the desired position

Commands

- Tap the screen (live view area) to take a picture
- Tap the varying directions to move the device accordingly.
- Tap on up arrow or down arrow to move AirSelfie up or

down in vertical direction.

- Tap circle arrow to steer AirSelfie .
- Tap to the left to move AirSelfie to the left.
- Tap to the right to move AirSelfie to the right.

6. Taking a photo or video

TO TAKE A PICTURE TAP ON THE SCREEN



Use the delay function (pg 5) to delay the shot by 3, 5 or 10 seconds.

This will allow you to put your smartphone away before posing for the picture.

TO RECORD A VIDEO CLICK ON THE  ICON CLICK  TO STOP RECORDING



7. Use the commands to return the AirSelfie to you

8. Do the **TOUCLAND**

9. Go to Home (click on the  icon) to **DOWNLOAD PHOTOS & VIDEOS** (pg 26)

FOR EMERGENCY STOP PRESS 

Standard control mode



Operation sequence

1. In Standard control mode, make sure that the camera is pointing in the opposite to you.



2. Slide to take off

3. Do the [TOSSFLY](#) (pg 14)

4. Tapping on any command icon will have the smartphone take control of the AirSelfie (notifying you with a vibration).

• B mode commands

Left

- Holding the up arrow button will cause the device to ascend until released.
- Holding the right arrow button will cause the device to rotate to the right.
- Holding the down arrow device will cause the model to descend.

Right

- Holding the “forward” arrow button makes the device move forward.
- Holding the “right” arrow button moves the device move to the right.
- Holding the “back” arrow button moves the device backwards.
- Holding the “left” arrow makes the device move left.

• J mode commands

Left

- Slide up to make the device ascend.
- Slide right to rotate the device right.
- Slide down to make the device descend.
- Slide left to rotate the device left.

Right

- Slide up to move the device forward.
- Slide right to make the device move forward/right.
- Slide down to move the device backward.
- Slide left to move the device forward/left.

• G mode commands

Right

- When operating under Gravity Mode, please tap and hold on the screen to keep Gravity Mode on.



- Pressing anywhere on the right side of the screen and tilting the smartphone forward will move the device forward.

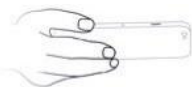

- Pressing anywhere on the right side of the screen and tilting the smartphone backwards will move the device backwards.



- Pressing anywhere on the right side of the screen and tilting the smartphone to the right will move the device to the right.





- Pressing anywhere on the right side of the screen and tilting the smartphone to the left will move the device to the left.

6. Taking a photo or video

TO TAKE PICTURE TAP ON THE SCREEN



Use the delay function (pg 4) to delay the shot by 3, 5 or 10 seconds. **This will allow you to put your smartphone away before posing for the picture.**

TO RECORD A VIDEO CLICK ON THE  ICON
CLICK  TO STOP RECORDING



7. Use the commands to return the AirSelfie to you

8. Do the **TOUCHLAND**

9. Go to Home (click on the  icon) and **DOWNLOAD PHOTOS & VIDEOS** (pg 26)

FOR EMERGENCY STOP PRESS 

Download photos & videos

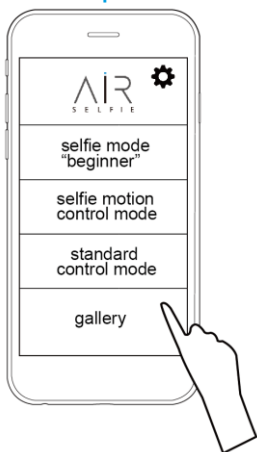

You can see all the photos/
videos in the memory card

Click to view photo or video



Click on the download icon to save the photo onto your smartphone



Choose which app you want to share the photo/video on



Deleting photos

Click SELECT



Choose the photo/video that you want to delete and click DELETE



GENERAL INFORMATION

Safety precautions and maintenance

This product is designed for recreational and leisure purposes. The pilot must always maintain direct visual contact with the product and monitor its trajectory.

The product must be used in accordance with the civil aviation regulations in your country.

Not suitable for children under 14 years of age. Small parts. Choking hazard. Do not fly near your face to avoid injuries. Risk of eye injuries. Do not throw or hold any objects in the rotating rotor.

Hands, hair and loose clothes must be kept away from the propeller (rotor). Do not touch the rotating rotor. Do not change or modify anything on the product.

Caution: Do not start up and fly when persons, animals or any obstructions are within the flying range of the product. Flight range: up to 20 m.

Before first use: read the manual. Flying this product requires skill and practice.

Note for adult supervisors: Check if the product is assembled as described.

Start and fly only when the area is appropriate for the intended use (free area, no obstructions) and only within direct visual contact. Start and fly is strictly forbidden near high voltage poles, railway tracks, roads, swimming pools or open water.

Only operate under good visibility and calm weather conditions. Irreversible damage may be caused if sand or dust gets into the product. Should this occur, your product may not function as intended.

The pilot must always maintain direct visual contact with the product and monitor its trajectory.

Do not pilot the product at night or in badly lit areas.

To safely use the FPV function the Drone must be flown by two competent people, one to fly the drone using the FPV module and the other as an observer. Both the pilot and the observer should ideally have flown the drone normally (without using the FPV) and be familiar with its functionalities. The observer should maintain visual contact with the drone at all times and be able to take over the controls quickly to avoid a collision or ensure a safe trajectory.

Read these instructions before use, follow them and keep them for reference.

All fixing elements in the pack must be removed by a competent adult. The product is equipped with a circuit powered by 1 rechargeable battery 7,4 V 240 mAh (included). To be used under the direct supervision of an adult. Do not use in other areas than private grounds. Do NOT open or modify the product or the Charger or change any components inside.

BATTERIES: the product includes Rechargeable Battery 7,4 V 240 mAh (included). The product must not be connected at a power rating higher than that advised for total of 7,4 V.

PREPARATION AND BATTERY CHARGE:

Adults must carry out any operations involving the electric system. Do not allow children to play with these components. Read these instructions before use, follow them and keep them for reference.

Do not charge the product that is hot, wet or shows signs of leakage or corrosion. Do not expose to fire, as this may result in explosion. Do not short circuit the battery. The article must be charged with the recommended battery charger. The charger is to be regularly examined for damage to the cord, plug enclosure and other parts. In the event of such damage, the charger must not be used until it has been repaired or replaced.

Prolonged charging will not improve the battery output, and could eventually damage the battery (pack). Do not disassemble the battery pack. This appliance is not intended for use by persons (including children) with reduced physical, sensory or mental capabilities, or lack of experience and knowledge, unless they have been given supervision or instruction concerning use of the appliance by a person responsible for their safety. Battery charger must be operated by adults only. The battery charger is not a toy.

BATTERY CAUTION: Do not short-circuit the battery contacts. Caution: Batteries inside this product may explode or leak when in contact with fire. In the event of electrolyte leakage, protect your eyes and hands. Put the product in a plastic bag or container until you can dispose of it safely. If you accidentally get electrolyte on your skin, wash thoroughly under running water and consult a doctor. AirSelfie will not be liable if the product is subject to alterations and/or tampering.

HELPFUL HINTS: Clean the product with a damp sponge or cloth – do not submerge the product into water. Protect the product from rain, snow and damp. Keep away from fire.

WARRANTY: Without prejudice to any applicable statutory warranty, AirSelfie warrants that the article will be free from defects in material and workmanship for a period of 12 months from the initial date of purchase (excluding consumables which are warranted during 6 months from the initial date of purchase) upon presentation of proof of purchase to the retailer.

Return to retailer is not applicable in the USA - return shall be made to AirSelfie. During the contractual warranty period, any defective product should be returned in its original packaging to the AirSelfie's after-sales service. After inspection of the product, AirSelfie will, at its sole discretion, either repair or replace the defective part or product, excluding any other indemnification of any nature.

AirSelfie's warranty does not cover:

defects due to damage caused by an accidental collision or fall; defects due to abnormal use of the product or if spare parts have been installed without following the recommendations and instructions provided by AirSelfie. If the AirSelfie has been customised by the end-user the warranty is not applicable. Defects caused by repairs carried out by the end-user or an unauthorized third party; defects due to the use of spare parts not provided by AirSelfie defects caused by any reason other than a defect in material or workmanship the gradual power loss of the AirSelfie rechargeable battery over time, which does not constitute as a defect in material or

workmanship.

If upon technical tests being carried out any product is found non-defective we reserve the right to return such product to the sender at the sender's cost and to levy a charge to cover AirSelfie's technical test fees.

Upon expiration of the 12-month warranty period or if the defect is not covered by the warranty, any defective product can be returned to AirSelfie's after-sales service in order to be repaired or for a defective part to be replaced at the sender's costs. Repair will be carried out only after acceptance of the corresponding quotation.

Except in relation to consumables, spare parts are subject to a 12 month warranty and are subject to the same terms and conditions as those described above.

The warranty does not cover: damage to all articles, including devices used to operate the AirSelfie.

PRIVACY

Recording and circulating an image or the voice of a person without their consent could constitute an infringement of their image and privacy rights and incur your liability. Ask for consent before filming people and recording their voices, particularly if you want to keep your recordings and/or share them on the Internet. Do not share any degrading images or sounds which could undermine the reputation or dignity of an individual.

The use of the AirSelfie for surveillance or espionage is strictly forbidden and could result in your prosecution under the law

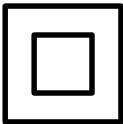

GB The product is only to be connected to Class II equipment bearing the following symbol - Class II equipment

Declaration of conformity

AirSelfie hereby declares that the radio equipment type AirSelfie flying camera is in compliance with Directive 2014/53/EU. The full text of the EU declaration of conformity is available at the following internet address: www.airselfiecamera.com

2.4 Ghz

ERP≤100 mW



Processing of electric and electronic equipment at the end of their service life.

This symbol, affixed to the product or its packaging, indicates that the product must not be processed with household waste. It must be brought to an electric and electronic waste collection point for recycling and disposal. By ensuring the appropriate disposal of this product you also help in preventing potentially negative consequences for the environment and human health. The recycling of materials helps preserve our natural resources.

For further information regarding the recycling of this product, please contact your municipality, local waste disposal centre or the store where the product was purchased.

During the replacement of your used batteries, we request that you follow the current regulations as to their elimination. We thank you for depositing them in a location foreseen for that purpose to ensure their elimination in a sure manner and with respect for the environment.

The explanations and specifications in this guide are given for information purposes only and may be modified without prior notice. However, AirSelfie shall not be held responsible for any consequences arising from any errors or omissions in the guide, nor for any damage or accidental loss of data resulting directly or indirectly from the use of the information herein. AirSelfie reserves the right to amend or improve the product design or user guide without any restrictions and without any obligation to notify users.

FCC COMPLIANCE STATEMENT

Maintain a safe distance of at least 20cm between yourself and the product while the product is in operation. Note that this is the minimum safe distance for operation.

This device complies with Part 15 of the FCC Rules. Its operation is subject to the following two conditions:

- (1) This device may not cause harmful interference.
- (2) This device must accept any interference received, including interference that may cause undesired operation.

Note: This product has been tested and found to comply with the limits for a Class B digital device, pursuant to Part 15 of the FCC Rules. These limits are designed to provide reasonable protection against harmful interference in a residential installation. This product generates, uses, and can radiate radio frequency energy and, if not installed and used in accordance with the instructions, may cause harmful interference to radio communications.

However, there is no guarantee that interference will not occur in a particular installation. If this product does cause harmful interference to radio or television reception, which can be determined by turning the equipment off and on, the user is encouraged to try to correct the interference by one or more of the following measures:

- Reorient or relocate the receiving antenna.
- Increase the separation between the equipment and receiver.
- Connect the equipment into an outlet on a circuit different from that to which the receiver is connected.
- Consult the dealer or an experienced radio/TV technician for help.

NOTE: THE GRANTEE IS NOT RESPONSIBLE FOR ANY CHANGES OR MODIFICATIONS NOT EXPRESSLY APPROVED BY THE PARTY RESPONSIBLE FOR COMPLIANCE. SUCH MODIFICATIONS COULD VOID THE USER'S AUTHORITY TO OPERATE THE EQUIPMENT.